

EXTRUDED SHAPES
DIRECT INDIRECT

SERIES E17-DI E17-I

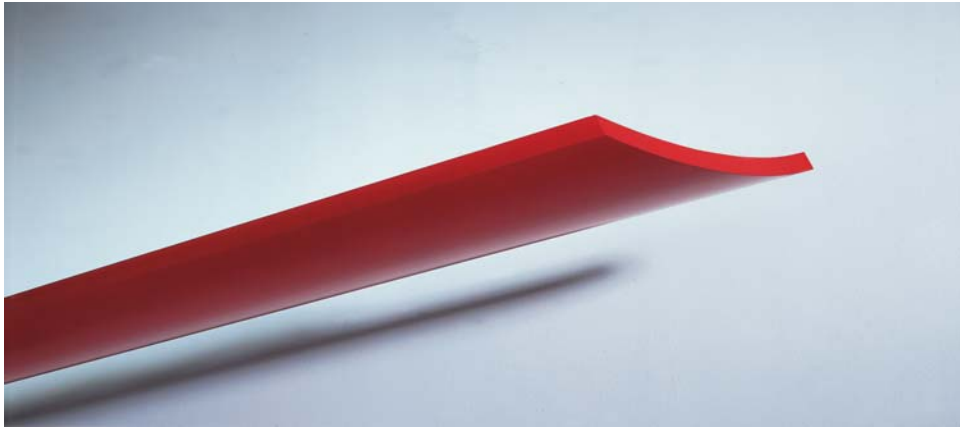

Options:

Mounting Options:

- AC** - Adjustable Aircraft Cable (48" Standard)
- P** - Pendant mounting (24" Standard)
- SP** - Swivel Pendant, 45° Limit
- W** - Wall Mounted

Lamp Options:

- T5** - 5/8" Diameter
- T5HO** - 5/8" Diameter (High Output)

Perforated Patterns:

- RSLT** - Rhombus perforations
- SSLT** - Square Perforations

Color Options:

- WHT** - White (Standard)
- CA** - Custom Colors

Electrical Options:

- 277** - 277 Volt Operation
- EM** - Emergency Ballast
- DIM** - Dimming Ballast
- GLR** - In Line Fusing
- 2CIR-2** Circuit Wiring

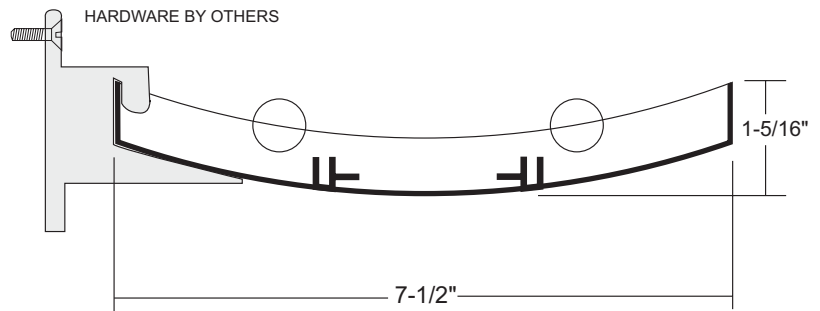
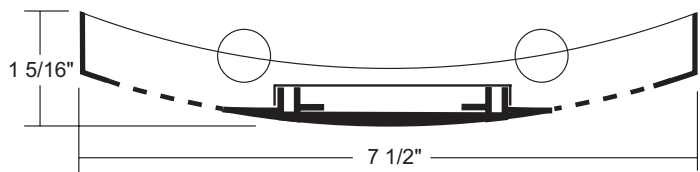

The PMC E17 Series, available with slotted downlight patterns, is an efficient uplight, with wide-spread distribution for low ceiling ratios. Standard fixtures are powder coated white, (custom colors available), reflective steel surfaces are high gloss white enamel (MRF 90%).

Fixtures are UL listed, and have **standard electronic ballasts**. Each fixture is lamp-tested at the factory before shipment.



ORDERING INFORMATION

E17 - DI - P - 2 / T5HO - 4 - SSLT - WHT- 120

SERIES NUMBER	DI	AC	2	T5	2	SSLT	277
LIGHT OUTPUT		P		T5HO	3	RSLT	EM
MOUNTING		SP			4		DIM
NUMBER OF LAMPS		W			6		GLR
LAMP TYPE					8		2CIR
LENGTH							
SLOTS(optional)							
COLOR							WHT
OPTIONS							Standard
							CA
							Custom
							Color

SERIES E17-DI

Pendant & Cable Mounting Locations

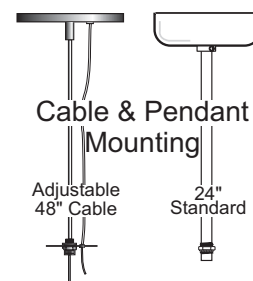
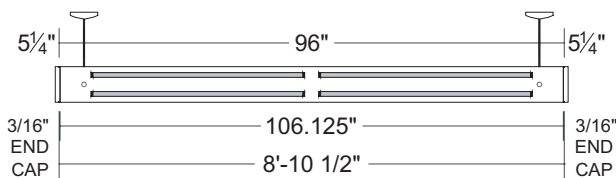
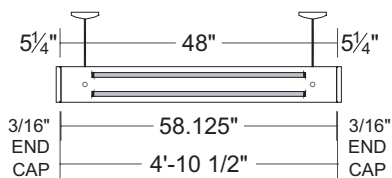

Wall Mounting Locations

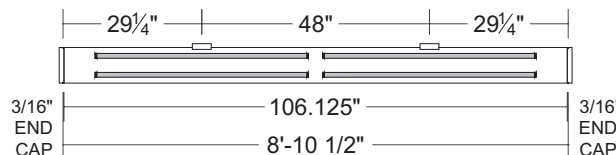
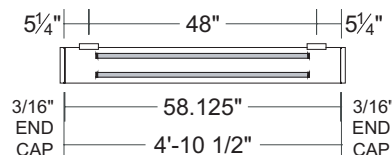

PHOTOMETRY

Model No: **E17-DI-AC-2/T5HO-4-PERF-120V-EB**
2 Lamps•5000 Lumens•Perf

Coefficients of Utilization

RCR	80%			70%			50%		
	70	50	30	70	50	30	50	30	10
0	.82	.82	.82	.70	.70	.70	.50	.50	.50
1	.74	.71	.68	.64	.61	.59	.44	.42	.41
2	.68	.62	.57	.58	.54	.50	.38	.36	.34
3	.62	.54	.48	.53	.47	.42	.34	.31	.28
4	.56	.48	.42	.48	.42	.37	.30	.27	.24
5	.51	.43	.36	.44	.37	.32	.27	.25	.21
6	.47	.38	.32	.41	.33	.28	.24	.20	.18
7	.44	.34	.28	.38	.30	.25	.22	.18	.16
8	.41	.31	.25	.35	.27	.22	.20	.16	.14
9	.38	.28	.23	.32	.25	.20	.18	.15	.12
10	.35	.26	.20	.30	.23	.18	.16	.13	.11

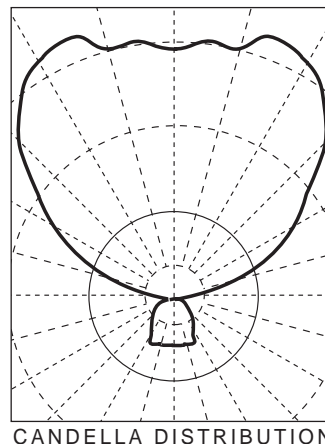

CANDELLA DISTRIBUTION

SPECIFICATIONS

CONSTRUCTION: Fixture Chassis formed of extruded aluminum alloy. Internal construction of 20 gauge, die formed CRS. When ordered with slot patterns, slots are backed with opal diffuser.

MOUNTING: Standard Pendant (**P**) stem is 1/4 IPS, 24" long with 5" Dia canopy. Swivel Pendant with 45° Limit, (**SP**) Adjustable length Aircraft Cable (**AC**) assembly has 48" cable, 5" Dia. canopy with cord for power locations.

FINISH: Standard fixtures are polyester powder-coated white. Reflective internal components are

finished in high gloss white enamel (Minimum Reflectance Factor 90%).

ELECTRICAL: All fixtures are UL listed, and are shipped fully wired, individually tested, with Electronic Ballasts shipped as standard equipment NOTE: Fixture accepts T5 lamps only.

PERFORATED PATTERNS: Square Pattern, backed with opal acrylic diffuser (**SSLT**). Rhombus pattern (**RSLT**), backed with opal acrylic diffuser.

FINISH: A range of custom colors are available to meet Architect specifications. Please consult the

factory.

ELECTRICAL: 277 Volt Ballast (**277**). Dimming Ballast (**DIM**). Emergency Ballast (**EM**) Note: unless specified, PMC will select ballasts to meet requirements. In Line Fusing (**GLR**). 2 Circuit Wiring (**2CIR**).

All dimensions are subject to change, Consult the factory before making structural alterations.



PMG LIGHTING
INCORPORATED