

4" SQ. APERTURE INCANDESCENT 12V MR16 LAMPS RECESSED DOWNLIGHT

RECESSED INCANDESCENT

OPTIONS:

Lamp Options:

75MR16 - 75 Watt MR16 Lamp
Maximum Wattage

Reflector Options:

CL - Clear Anodized (standard)
GA - Gold Anodized
CA - Champagne Anodized
WA - Wheat Anodized
SA - Straw Anodized
PA - Pewter Anodized
GM - Gun Metal Anodized
UA - Umber Anodized
PW - Painted White
PB - Painted Black
HZ - Haze

Baffle Options:

MB - Black Micro Baffle
WB - White Micro Baffle
BRB - Bronze Micro Baffle

Electrical Options:

120 - 120 Volt Operation
277 - 277 Volt Operation
GLR - In Line Fusing

Glass Options:

CGS - Clear
F - Frosted
LWW - Lens Wall Wash

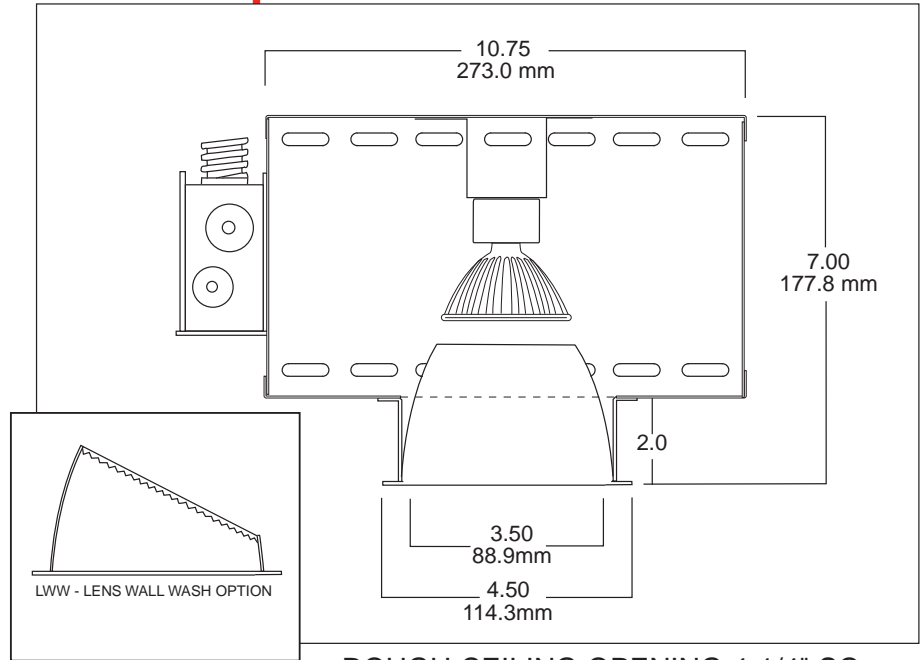

ROUGH CEILING OPENING 4-1/4" SQ.

PRODUCT SPECIFICATION DATA:

Steel (matte black) Housing
Low iridescent specular Alzak® reflector.
Designed for 1 vertical MR16 series lamp.
Lamps by others.
Pulse-rated porcelain socket.
Capable of mounting in 2" thick ceiling.
Positive trim retention.
Thermal protection.
14 Gauge galvanized junction box with
snap-on covers.
Suitable for through wiring (4in/4out) #12 AWG.
Factory wired for ease in installation.
ETL/CSA Listed / Damp Location.
Chicago Plenum-CCEA - consult factory.
Bar Hangers Standard

ORDERING INFORMATION

INP-SQ - 4 - 75MR16 - CL - 120 -

LIGHT SOURCE	APERTURE	LAMP	REFLECTOR OR BAFFLE	ELECTRICAL	GLASS
INCANDESCENT SQUARE		20MR16 50MR16 65MR16 71MR16 75MR16	CL GA CA WA SA PA GM UA PW PB HZ	MB WB BRB 120 277 GLR	CGS F LWW

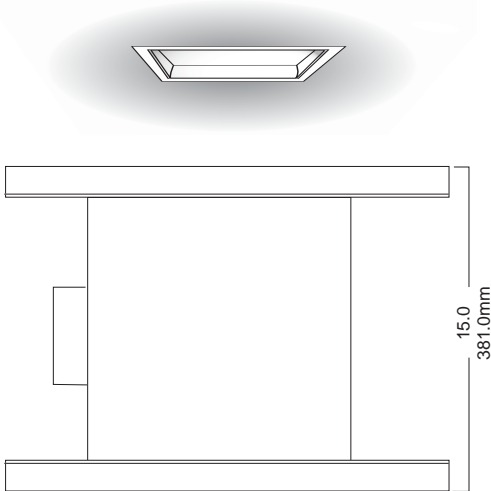

a division of PMC Lighting Inc

4" APERTURE

INCANDESCENT 12 VOLT MR16 LAMPS
RECESSED DOWNLIGHT

PHOTOMETRICS

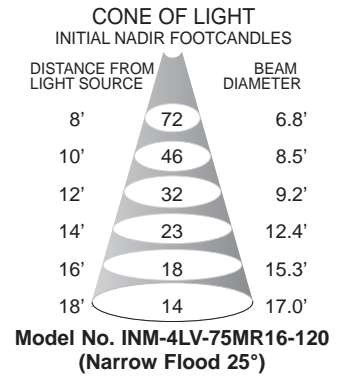
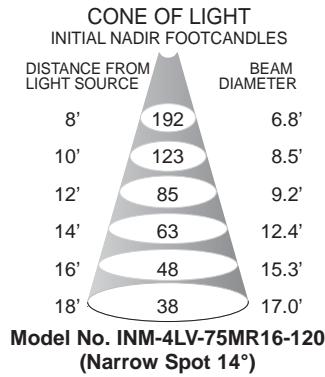
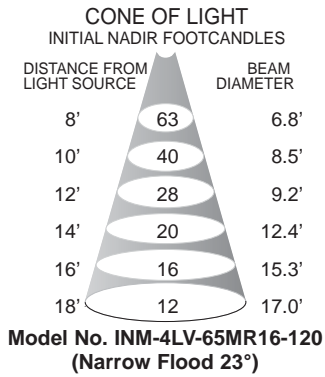
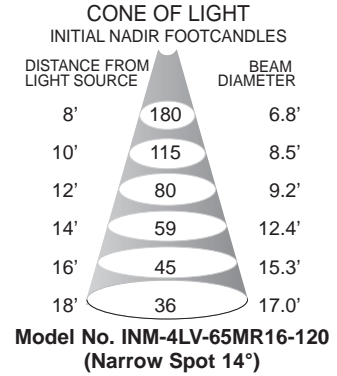
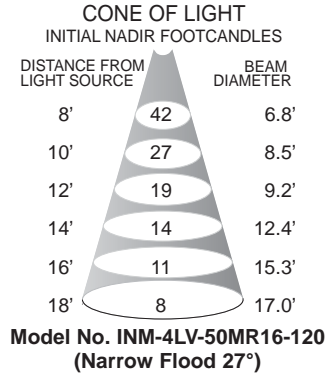
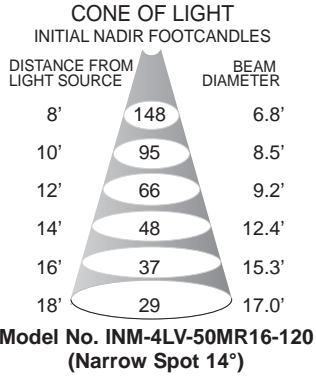

a division of PMC Lighting Inc